

# ADVANCED Line Comfort 2 TW

**Schneider**  
my ultimate mirror experience

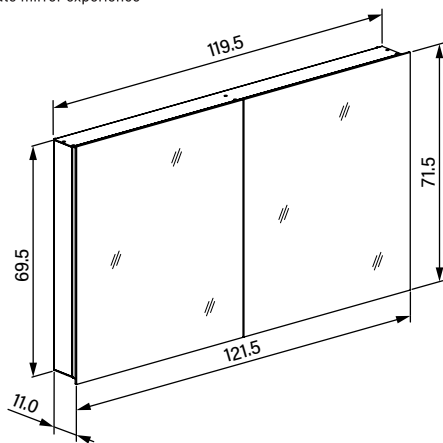

**LED**  
2000 - 6500 K



Artikel 1. Ausgabe  
Article **622 036** 1. Edition **04-2021**  
Articolo 1. Edizione

Art. No. **194.120** Mut.

**Spiegelschrank ALC2 120/2/TW**  
**Armoire-miroir ALC2 120/2/TW**  
**Armadio specchio ALC2 120/2/TW**

W. Schneider+Co AG, CH-8135 Langnau a.A.  
www.wschneider.com © 2021

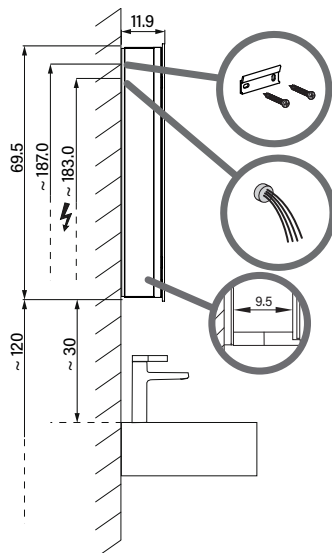

Aufputz-Montage **AP**  
Pose en applique  
Surface mounting

ALC2/TW/AP	A
50..	19
60..	29
70..	39
80..	49
90..	59
100..	69
120..	89
130..	99
140..	109
150..	119

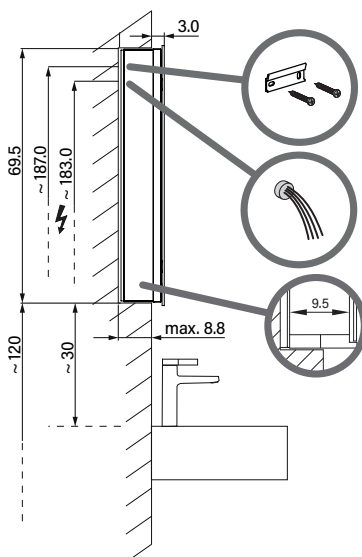
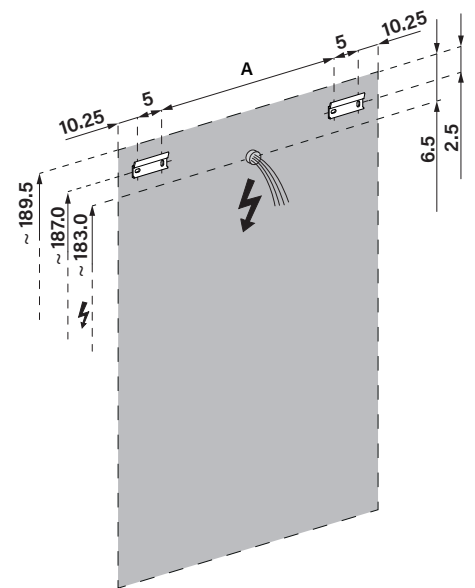

Unterputz-Montage **UP**  
Pose en encastrement  
Recessed mounting

ALC2/UP	B
50..	49.5
60..	59.5
70..	69.5
80..	79.5
90..	89.5
100..	99.5
120..	119.5
130..	129.5
140..	139.5
150..	149.5

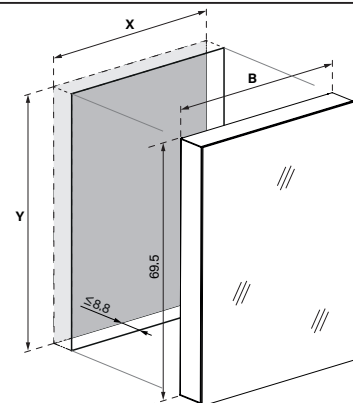

UP-Montage: Nischengröße X x Y und Befestigung Spiegelschrank sind bauteils zu bestimmen.

Montage encastré: la taille de la niche X x Y et la fixation de l'armoire-miroir doivent être déterminées par le client.

Flush mounting: the recess dimensions X by Y and the fixing system for the mirrored cabinet will need to be determined on site.

Die Massangaben in cm verstehen sich unter dem Vorbehalt der Werkstoleranzen, eventuell späterer Änderungen sowie weiterer Montagemöglichkeiten. Die Haftung für Folgen fehlerhafter oder unvollständiger Massangaben ist ausgeschlossen. (Art. 100 OR).

Les dimensions en cm s'entendent sous réserve des tolérances d'usine, d'éventuelles modifications ultérieures, de même que de nouvelles possibilités de montage. La responsabilité ne peut être engagée en cas de cotes manquantes ou erronées (CD art. 100).

Le dimensioni in cm s'intendono fatte salve le tolleranze di fabbricazione, le eventuali modifiche successive e le ulteriori alternative di montaggio. Si declina qualsiasi responsabilità per le conseguenze legate a dimensioni errate o incomplete (art. 100 CO).